

Gas-Phase Reactions of Oxide Radical Ion and Hydroxide Ion with Simple Olefins and of Carbanions with Oxygen

Diethard K. Bohme¹ and L. Brewster Young²

Contribution from the Aeronomy Laboratory,
Environmental Science Services Administration Research Laboratories,
Boulder, Colorado 80302. Received November 10, 1969

Abstract: Reaction channels, branching ratios, and rate constants have been measured and reaction probabilities have been calculated for the reactions of oxide radical ion and hydroxide ion with simple olefins and for the reactions of carbanions with molecular oxygen. All investigations were carried out in a flowing afterglow system in the gas phase at 22.5° under conditions of thermal equilibrium. Oxide radical ion reacts rapidly and efficiently with allene, propene, 2-methylpropene, 1-butene, and *cis*- and *trans*-2-butene to abstract either a hydrogen atom to yield hydroxide ion or a proton to yield a carbanion. Rate constants are of the order of $7 \times 10^{11} M^{-1} \text{sec}^{-1}$ and reaction probabilities range from 0.42 to 0.84. The reaction of oxide radical ion with ethylene is believed to proceed *via* associative detachment. Hydroxide ion reacts efficiently with the simple olefins except ethylene only by proton abstraction to yield the conjugate base of the carbon acid. Rate constants and reaction probabilities range from 1.6 to $5.3 \times 10^{11} M^{-1} \text{sec}^{-1}$ and 0.11 to 0.46, respectively. The following gas-phase acidity order has been observed: simple olefins > water > ethylene, saturated hydrocarbons. The carbanions $C_3H_3^-$, $C_3H_5^-$, and $C_4H_7^-$ react with molecular oxygen *via* a variety of channels including electron transfer, hydride transfer, and rearrangement. The observed reaction kinetics has been used to estimate limits for the standard heats of formation of $C_2H_3^-$, $C_3H_3^-$, $C_3H_5^-$, and $C_4H_7^-$ and limits for the electron affinities of the corresponding free radicals.

Recent gas-phase investigations of negative-ion organic chemistry have illustrated the difficulties inherent in the determination of the intrinsic kinetics and thermodynamics of organic reactions from solution measurements. For example, detailed examinations of Brønsted acid-base reactions by ion cyclotron resonance spectroscopy³ and in tandem mass spectrometers⁴ have established that intrinsic acidities can differ markedly from solution acidities in which such perturbations as hydrogen bonding, specific solvation, and aggregation can have overriding influences. It is the purpose of this paper to describe a generally useful technique for the study of *thermal energy* organic ion-molecule reactions in the gas phase and to report quantitative measurements of the intrinsic kinetics of the reactions of the oxide radical ion, O^- , and the hydroxide ion, OH^- , with unsaturated hydrocarbon molecules, and of the reactions of carbanions with molecular oxygen. Rate constants and product channels for these reactions have been measured directly and intrinsic reactivities have been calculated. The results indicate that in most cases the reactions of O^- and OH^- with olefins proceed extremely rapidly and efficiently in the gas phase. The reactions of the carbanions with oxygen provide a measure of the intrinsic stability of these ions. It is expected that such information will facilitate the understanding and possibly the prediction of modes of acid-base and carbanion reactions in solution.

(1) National Research Council of U. S. Postdoctoral Research Associate, 1967-1969. Address correspondence to this author at the Department of Chemistry, York University, Toronto 12, Ontario, Canada.

(2) National Institutes of Health (Fellowship No. 5F02GM31718-02, National Institute of General Medical Sciences) Postdoctoral Fellow, 1968-1970.

(3) J. I. Brauman and L. K. Blair, *J. Amer. Chem. Soc.*, **90**, 5636, 6561 (1968).

(4) T. O. Tiernan and B. M. Hughes, Proceedings of the 17th Annual Conference on Mass Spectrometry and Allied Topics, Dallas, Texas, May 1969, p 208.

Experimental Section

Apparatus and Reagents. A flowing afterglow system has been utilized in this laboratory for several years principally for the investigation of thermal energy ion-molecule reactions of interest in the earth's ionosphere. The description and application of this technique with reference to these studies have been reported in detail previously.⁵ Since the present paper deals with the novel application of the technique to negative-ion organic chemistry in the gas phase, a brief outline with reference to these investigations is felt to be appropriate.

A schematic diagram of the apparatus is shown in Figure 1. The flow system is a stainless steel tube about 100 cm long with an internal diameter of 8 cm. A fast gas flow with a velocity of about 10^4 cm/sec is established in the tube by a Roots-type pump backed by a mechanical forepump. Helium is normally used as a carrier or buffer gas. With a helium flow of 180 atm cm³/sec and maximum pumping speed, the helium pressure in the tube is typically about 0.4 Torr. Negative ions are produced either directly in the excitation region by ionizing the parent gas of the ion with 100-eV electrons or indirectly by secondary reaction downstream from the excitation region. In the present experiments pure oxygen was introduced into the excitation region *via* source gas inlet 1. The O^- ion is then produced by the dissociative ionization reaction

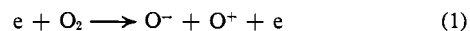

and, probably to a much lesser extent, the dissociative attachment reaction



For the production of hydroxide ions, ammonia was added into source gas inlet 2. Hydroxide ions are then produced indirectly by the rapid hydrogen atom abstraction reaction of O^- with ammonia

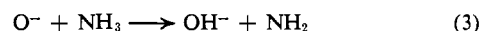

which has a measured rate constant of $7.2 \times 10^{11} M^{-1} \text{sec}^{-1}$ in the gas phase.⁶ The carbanions were generated by the addition of the corresponding unsaturated hydrocarbon *via* source gas inlet 2 to a helium afterglow containing O^- . The direct proton transfer reaction

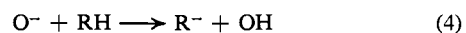

(5) E. E. Ferguson, *Advan. Electron. Electron Phys.*, **24**, 1 (1968); E. E. Ferguson, F. C. Fehsenfeld, and A. L. Schmeltekopf, *Advan. At. Mol. Phys.*, **5**, 1 (1969).

(6) D. K. Bohme and F. C. Fehsenfeld, *Can. J. Chem.*, **47**, 2715 (1969).

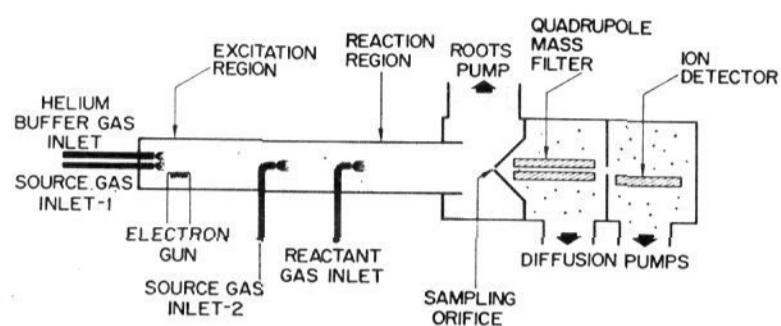
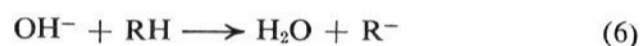
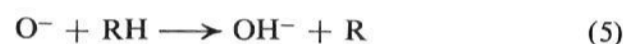

Figure 1. Schematic diagram of the flowing afterglow apparatus.

or the reaction sequence involving hydrogen atom abstraction followed by proton abstraction



will then yield the desired carbanion. The various negative ions produced in the manner described above equilibrate for several milliseconds before they enter the reaction region, into which the desired neutral reactant gas is added, *via* the reactant gas inlet, in measured amounts. The unsaturated hydrocarbon gases had the following minimum purity in mol %: ethylene, 99.5; allene, 97; propene, 2-methylpropene, 1-butene, *cis*- and *trans*-2-butene, 99.0. The helium buffer gas had a purity of 99.995 mol % and the oxygen had a minimum purity of 99.95 mol %. In the region following the reactant gas addition, characteristic reactions between the negative ions and the reactant gas take place. The reaction region is terminated by the sampling orifice of a mass spectrometer. The ion composition is then sampled, mass analyzed by means of a quadrupole mass spectrometer, and counted.

Data Analysis. The decline of the primary ion signal and the variation of the secondary ion signals as a function of reactant gas addition allow the determination of both reaction rate constants for the loss of primary and secondary ions and branching ratios for the various product channels. The branching ratio is defined as the ratio of the rate constant for the formation of a particular product ion to the rate constant for the loss of the source of this product ion or the sum of the rate constants for the formation of all the product ions. Isotope analysis is usually required when the chemical composition of a product ion is not unequivocally determined by stoichiometry.

The accuracy of rate constants obtained using the flowing afterglow technique has been conservatively estimated as $\pm 30\%$ due to the complexities of the aerodynamic analysis of the system.⁵ However, it has become apparent that for reactant gases for which the viscosities are well known, rate constants can be obtained with considerably more accuracy than $\pm 30\%$, probably approaching $\pm 10\%$. It is considered, therefore, that for the hydrocarbon gases utilized in this study, rate constants have an absolute accuracy of better than $\pm 30\%$, and probably have a relative accuracy of $\pm 10\%$ or less.

Figure 2 shows a set of data for the reaction sequence beginning with O^- in reaction with allene. As allene is added into the reaction region the O^- signal declines and there is a corresponding rise in the negative ion signals with *m/e* 17, 39, and 41. The initial decline in the O^- signal yields a rate constant of $6.4 \times 10^{11} \text{ M}^{-1} \text{ sec}^{-1}$ for the reaction of O^- with allene. Stoichiometry identifies the ion with *m/e* 17 as OH^- , which in turn identifies the reaction channel

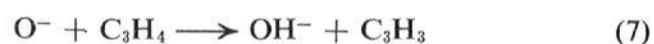

The OH^- product ion signal increases to a maximum and then declines. This decline yields a rate constant of $4.5 \times 10^{11} \text{ M}^{-1} \text{ sec}^{-1}$ for the reaction of OH^- with allene. Stoichiometry identifies the ion with *m/e* 39 as C_3H_3^- . Product channel analysis (*vide infra*) dictates that the formation of this carbanion is the major channel in the reaction of O^- with allene, according to the following process



The ion with *m/e* 41 was shown not to be a significant product of the reaction of O^- with allene. The product ion mass ratio 39/41 was observed to be dependent on the oxygen source gas flow. An independent series of experiments in which C_3H_3^- was generated upstream and oxygen was added deliberately into the reaction region

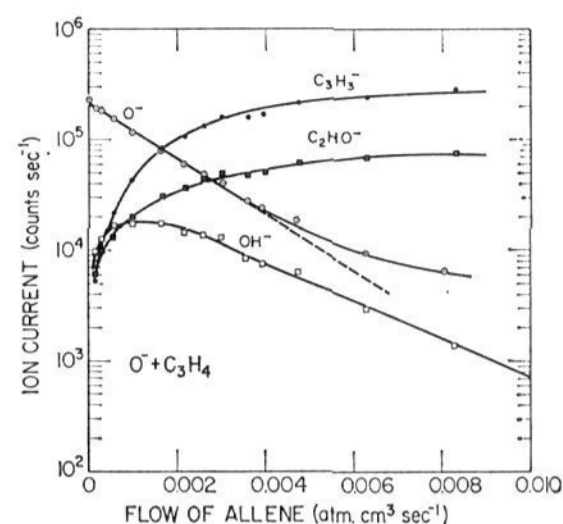
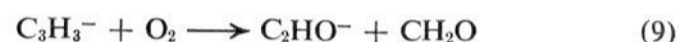
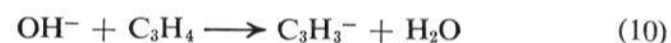

Figure 2. Variation of reactant and product ion signals with addition of allene for the reaction sequence beginning with O^- in reaction with allene.

established the source of the mass 41 ion to be the reaction



This result establishes that the reaction of OH^- with allene proceeds principally according to the proton abstraction reaction



Several methods have been used to obtain numerical estimates of product channel branching ratios. In the event that the product ions do not react further with the added reactant gas, the relative magnitudes of the product ion signals at large additions of the reactant gas, *i.e.*, at saturation, can be taken to be a measure of the relative magnitudes of the rate coefficients for the formation of the various product ions. When the product ion reacts further as in eq 10, other procedures must be used to obtain the product channel branching ratio. One method involves a determination of the hypothetical saturated value of the product ion current if there were no further reaction. The relative magnitude of this saturated value of the product ion current and the initial primary ion current may then be taken to be a measure of the branching ratio for the channel leading to the formation of that product ion. The hypothetical saturated value of the product ion current is obtained by extrapolating the product ion decay curve to zero addition of reactant gas. The intercept is then multiplied by the factor $(1 - k_s/k_p)$ where k_s and k_p are the rate constants for the loss of the product ion and primary ion, respectively. The factor $(1 - k_s/k_p)$ is readily derived from the limits with respect to reactant gas concentration of the exact solution for the product ion concentration of the coupled equations involving the production and loss of the product ion. A second procedure which can be used to obtain the product channel branching ratio when the product ion reacts further involves a consideration of the relative magnitudes of the product ion current and the primary ion current at the product ion current maximum. At the product ion current maximum the rate of formation of product ion is equal to its rate of loss by reaction, *i.e.*

$$k_F[\text{P}^-][\text{X}] = k_s[\text{S}^-][\text{X}] \quad (11)$$

where $[\text{P}^-]$ and $[\text{S}^-]$ are the concentrations of the primary ion and secondary (product) ion, respectively, $[\text{X}]$ is the concentration of the reactant gas, and k_F and k_s are the rate constants for the formation and reaction of the product ion. The above expression simplifies to

$$k_F = \frac{[\text{S}^-]}{[\text{P}^-]} k_s \quad (12)$$

so that k_F is readily evaluated. The ratio k_F/k_p is then a measure of the branching ratio. The major source of error in the determination of the branching ratio by the methods described above is mass discrimination in the detection system.

The intrinsic reactivities of the various negative ions were estimated in terms of a reaction efficiency or reaction probability, P , which is defined as the ratio of the experimentally determined rate constant, k_{exptl} , to the theoretical collision rate constant, k_L , *i.e.*, $P = k_{\text{exptl}}/k_L$. For an ion colliding with a nonpolar neutral mole-

Table I. Branching Ratios, Rate Constants, and Reaction Probabilities for the Reactions of O⁻ with Hydrocarbons at 22.5°

Reaction	Branching ratio ^a	$k_{\text{exptl}},^b M^{-1} \text{sec}^{-1}$	$k_L,^c M^{-1} \text{sec}^{-1}$	P^d
O ⁻ + C ₂ H ₆ → OH ⁻ + C ₂ H ₅		4.2 (11) ^{e,f}	9.0 (11)	0.47
O ⁻ + C ₂ H ₄ → C ₂ H ₄ O + e		4.6 (11)	9.0 (11)	0.51
O ⁻ + C ₃ H ₄ → C ₃ H ₃ ⁻ + OH	0.90 ± 0.05			
→ OH ⁻ + C ₃ H ₃	0.10 ± 0.05	6.4 (11)		
O ⁻ + C ₃ H ₆ → OH ⁻ + C ₃ H ₅	0.95 ± 0.05			
→ C ₃ H ₅ ⁻ + OH	0.05 ± 0.05	6.0 (11)	1.44 (12)	0.42
O ⁻ + <i>i</i> -C ₄ H ₈ → OH ⁻ + C ₄ H ₇	0.95 ± 0.05			
→ C ₄ H ₇ ⁻ + OH	0.05 ± 0.05	8.4 (11)	1.80 (12)	0.47
O ⁻ + 1-C ₄ H ₈ → C ₄ H ₇ ⁻ + OH	0.6 ± 0.1			
→ OH ⁻ + C ₄ H ₇	0.4 ± 0.1	8.4 (11)	1.62 (12)	0.52
O ⁻ + <i>cis</i> -2-C ₄ H ₈ → C ₄ H ₇ ⁻ + OH	0.6 ± 0.1			
→ OH ⁻ + C ₄ H ₇	0.4 ± 0.1	7.2 (11)	1.14 (12)	0.63
O ⁻ + <i>trans</i> -2-C ₄ H ₈ → C ₄ H ₇ ⁻ + OH	0.6 ± 0.1			
→ OH ⁻ + C ₄ H ₇	0.4 ± 0.1	9.6 (11)	1.14 (12)	0.84

^a The listed values and estimated errors represent averages of values obtained by two distinct methods (see Experimental Section). ^b Rate constant for the loss of O⁻. To convert rate constants to cm³ molecule⁻¹ sec⁻¹ divide by 6 × 10²⁰. ^c Theoretical collision rate constant. ^d Reaction probability, k_{exptl}/k_L . ^e (11) denotes 10¹¹. ^f From ref 8.

cule, the theoretical collision rate constant is given by the expression

$$k_L = 2\pi e \left(\frac{\alpha}{\mu} \right)^{1/2} \quad (13)$$

where μ is the reduced mass of the reactants, e is the electronic charge, and α is the polarizability of the neutral substrate.⁷ Equation 13 is derived on the assumption that the ion-molecule reaction can be treated in terms of point particles and that the total collision cross section is determined solely by the long-range ion-induced dipole interaction which results in spiraling or orbiting. Experimental results obtained in recent years have adequately demonstrated that eq 13 gives a reasonably accurate estimate of the maximum expected value for k_{exptl} at low energies.⁵ The actual value of k_{exptl} will of course depend on the energetics and mechanism of the reaction under consideration, the reaction probability being a measure of the deviation of k_{exptl} from k_L . Experimentally observed deviations from k_L may be interpreted in terms of such classical concepts as steric hindrance and activation energy barriers.

Results and Discussion

Reactions of the Oxide Radical Ion, O⁻, with Unsaturated Hydrocarbons. Results from earlier gas-phase investigations⁸ have revealed that O⁻ ions react efficiently with the saturated hydrocarbon molecules methane, ethane, propane, and *n*-butane. Hydrogen atom abstraction, eq 14, was observed to be the only significant reaction channel, and the reaction probability for this process was found to increase for higher members of the homologous series.

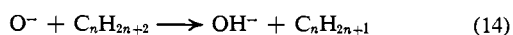

The results of the present investigations have indicated that O⁻ ions also react efficiently with unsaturated hydrocarbons in the gas phase. However, in addition to the hydrogen atom abstraction channel, eq 15a, a proton abstraction channel, eq 15b, could be identified

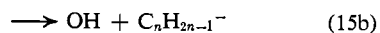
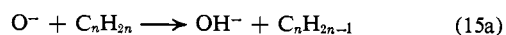

and was the dominant reaction channel in several cases. The measured rate constants, the branching ratios for the various product channels, and the calculated reaction probabilities are listed in Table I. All the reaction channels with the exception of the formation of C₃H₅⁻ from propene were calculated to be

(7) G. Gloumoussis and D. P. Stevenson, *J. Chem. Phys.*, **29**, 294 (1958).

(8) D. K. Bohme and F. C. Fehsenfeld, *Can. J. Chem.*, **47**, 2717 (1969).

exothermic or nearly thermoneutral using the best available values for the C-H bond energies and the electron affinities of O and OH (*vide infra*). The *m/e* of the product ion was identified in all cases. When the chemical composition of the product ions was not specified by stoichiometry, the major product ions were identified by isotope analysis. The most abundant product ion in the reaction of O⁻ with the linear butenes had *m/e* 55 which, according to stoichiometry, may be either C₄H₇⁻ or C₃H₃O⁻. However, the formation of the oxygen-containing anion is expected to be unlikely on mechanistic grounds since it would require considerable bond breaking. In addition, measurement of the (P + 1)/P ratio for the *m/e* 55 ion gave a value of 0.045 which is more consistent with the formulation C₄H₇⁻ ((P + 1)/P = 0.0433) than C₃H₃O⁻ ((P + 1)/P = 0.0333). The signal-to-noise ratio for the P + 2 peak was not sufficiently large for an accurate isotope measurement to be made.

It can be seen in Table I that the reaction of O⁻ with allene proceeds principally by proton abstraction, whereas propene and 2-methylpropene react principally by hydrogen atom abstraction. In comparison the linear butenes react by both hydrogen atom and proton abstraction in about equal proportions, the formation of the carbanion being slightly favored. It appears that within the accuracy of the values of the C-H bond energies reported in the literature, carbanion formation, *i.e.*, proton abstraction, is favored over OH⁻ formation, *i.e.*, hydrogen atom abstraction, whenever the channel leading to the production of the carbanion is calculated to be exothermic.

The reaction of O⁻ with propene has recently been investigated in the gas phase by Hughes and Tiernan⁹ in a tandem mass spectrometer at impacting ion energies of 0.3 ± 0.3 eV. Their results indicate an overall rate constant for the loss¹⁰ of O⁻ of 4.4 × 10¹¹ M⁻¹ sec⁻¹ with 93.0% of the reaction proceeding by hydrogen atom abstraction, 5.5% of the reaction leading to the formation of C₃H₄⁻ and H₂O, and 1.5% of the reaction proceeding by proton abstraction. The rate constant for the loss of O⁻ and the designation

(9) B. M. Hughes and T. O. Tiernan, private communication.

(10) It is assumed here that all the product channels were identified in the tandem mass spectrometer experiments so that the rate constant for the loss of the primary ion is equal to the sum of the rate constants for the formation of product ions.

Table II. Rate Constants and Reaction Probabilities for the Reactions of OH⁻ with Hydrocarbons at 22.5°

Reaction	$k_{\text{exptl}},^a M^{-1} \text{sec}^{-1}$	$k_L,^b M^{-1} \text{sec}^{-1}$	P^c
OH ⁻ + C ₂ H ₆ → C ₂ H ₅ ⁻ + H ₂ O	≤6.0 (8) ^{d,e}	9.0 (11)	≤7.0 (-4)
OH ⁻ + C ₂ H ₄ → C ₂ H ₃ ⁻ + H ₂ O	≤6.0 (8)	9.0 (11)	≤7.0 (-4)
OH ⁻ + C ₃ H ₄ → C ₃ H ₃ ⁻ + H ₂ O	4.5 (11)		
OH ⁻ + C ₃ H ₆ → C ₃ H ₅ ⁻ + H ₂ O	1.6 (11)	1.44 (12)	0.11
OH ⁻ + 1-C ₄ H ₆ → C ₄ H ₅ ⁻ + H ₂ O	5.3 (11)	1.62 (12)	0.33
OH ⁻ + <i>cis</i> -2-C ₄ H ₈ → C ₄ H ₇ ⁻ + H ₂ O	4.3 (11)	1.14 (12)	0.38
OH ⁻ + <i>trans</i> -2-C ₄ H ₈ → C ₄ H ₇ ⁻ + H ₂ O	5.2 (11)	1.14 (12)	0.46
OH ⁻ + <i>i</i> -C ₄ H ₈ → C ₄ H ₇ ⁻ + H ₂ O	3.8 (11)	1.80 (12)	0.21

^a Rate constant for loss of OH⁻. To convert rate constants to cm³ molecule⁻¹ sec⁻¹ divide by 6 × 10²⁰. ^b Theoretical collision rate constant. ^c Reaction probability, k_{exptl}/k_L . ^d (8) denotes 10⁸. ^e From ref 8.

of the major reaction are in reasonable agreement with the present results obtained at 22.5° (Table I). Agreement is, however, not expected, *a priori*, since the energy dependencies of the rate constant and the branching ratio for such reactions are not known.

The reaction of O⁻ with ethylene was found to be unique in that no ions with an intensity of at least 10% of the primary O⁻ signal could be observed in the product mass spectrum. We have therefore assigned the reaction channel to correspond to associative detachment¹¹ (Table I). The associative detachment reaction to yield ethylene oxide is calculated to be far more exothermic than the hydrogen atom abstraction reaction to yield the vinyl radical and is apparently the preferred process at 22.5°. There was no evidence of a significant reaction channel corresponding to associative detachment in the reaction of O⁻ with the unsaturated hydrocarbons allene, propene, 2-methylpropene, 1-butene, and *cis*- and *trans*-2-butene. In each of these cases there was a balance of the product and reactant negative ion signals to within experimental error.

The reaction of O⁻ with ethylene was also investigated by Hughes and Tiernan in their tandem mass spectrometer at impacting ion energies of 0.3 ± 0.3 eV.⁹ These investigators observed the reaction products C₂H₂⁻ (80%) and OH⁻ (20%). The sum of the formation rate constants for the production of these two ions was 1.8 × 10¹¹ M⁻¹ sec⁻¹. This value is lower by a factor of 3.6 than the value for the rate constant obtained in the present experiments for the loss of O⁻. It must be pointed out, however, that the tandem mass spectrometer experiments of Hughes and Tiernan were not suited for the detection of an associative detachment channel. Nevertheless, there appears to be some discrepancy between the rate constant for the formation of OH⁻ and C₂H₂⁻ observed in the tandem mass spectrometer (1.8 × 10¹¹ M⁻¹ sec⁻¹) and the upper limit to the rate constant of 4.6 × 10¹⁰ M⁻¹ sec⁻¹ for the formation of these anions estimated in the present flowing afterglow experiments. This discrepancy between the tandem mass spectrometer data obtained at ion energies of 0.3 ± 0.3 eV and the flowing afterglow data obtained under thermal equilibrium conditions at 22.5° raises interesting questions regarding the energy dependence of the rate constants and branching ratios of the product channels.

(11) The occurrence of associative detachment reactions in the gas phase has only recently been established experimentally for simple inorganic systems.¹² The associative detachment reaction of O⁻ with ethylene is the first such reaction measured in the gas phase involving an organic substrate.

(12) F. C. Fehsenfeld, E. E. Ferguson, and A. L. Schmeltekopf, *J. Chem. Phys.*, **45**, 1844 (1966).

It is of interest to compare the reactivity of O⁻ in the gas phase to its reactivity in solution. Such comparisons may represent a significant step in understanding the role of solvation in determining the energetics and kinetics of ion-molecule reactions in solution. We are not aware of any previous solution measurements of the reactions of O⁻ with olefins. However, the reactivity of O⁻ has recently been investigated by pulse radiolysis in aqueous solutions containing methanol and ethanol at pH >13 by Gall and Dorfman, who reported that O⁻ in aqueous solution reacts with methanol and ethanol by hydrogen atom abstraction with rate constants of (5.2 ± 1.0) × 10⁸ and (8.4 ± 1.6) × 10⁸ M⁻¹ sec⁻¹, respectively, at 25°. ¹³ Hughes and Tiernan reported rate constants of 2.8 × 10¹¹ and 2.4 × 10¹¹ M⁻¹ sec⁻¹, respectively, for these two hydrogen atom abstraction reactions in the gas phase at ion energies of 0.3 ± 0.3 eV.⁹ Thus the rates of the reactions of O⁻ with methanol and ethanol are seen to be several hundred times faster in the gas phase than in aqueous solution. These results need to be rationalized in terms of the role of solvent in the determination of the kinetics and energetics of reaction.

Reactions of the Hydroxide Ion, OH⁻, with Unsaturated Hydrocarbons. It has been found in the present study that OH⁻ reacts with unsaturated hydrocarbons to form the conjugate base of the carbon acid and water. The observed reaction channels, measured rate constants, and calculated reaction probabilities are summarized in Table I. The *m/e* 39 ion was determined by stoichiometry to be C₃H₃⁻. The formula C₃H₅⁻ was assigned to the *m/e* 41 ion on the basis of a measurement of the (P+1)/P isotope ratio. The basis for the assignment of the formula C₄H₇⁻ to the *m/e* 55 ion has already been discussed. Insufficient knowledge of the electron affinities of unsaturated free radicals prevented the calculation of the energetics of the OH⁻ reactions. Instead the observation of reaction or the failure to observe reaction was used to estimate limits to these electron affinities (*vide infra*).

It can be seen from Table II that within the limits of our experimental technique certain hydrocarbons such as ethane and ethylene do not react with OH⁻, whereas allene, propene, 2-methylpropene, and 1-, *cis*-2-, and *trans*-2-butene react rapidly to form the corresponding carbanion and water. Since neither the sp² proton of ethylene nor the sp³ proton of ethane is abstracted by OH⁻, it seems reasonable to assume

(13) B. L. Gall and L. M. Dorfman, *J. Amer. Chem. Soc.*, **91**, 2199 (1969).

that it is an allylic proton which is transferred from the reactive hydrocarbons to OH^- forming an allylic carbanion.

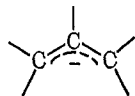

The strongly basic nature of OH^- in the gas phase compared to solution is illustrated by its ability to abstract a proton from the very weakly acidic olefins utilized in this study. The present results indicate the acidity order: propene, 2-methylpropene, 1-, *cis*-2-, *trans*-2-butene, allene > water > ethylene, ethane. This gas-phase acidity order may be compared to that in solution where the pK_a 's of propene, water, ethylene, and ethane are 35.5, 15.7, 36.5, and 42, respectively.¹⁴ It is evident from this comparison that the findings in the gas phase indicate a reversal of the acidity order found in solution where water is the strongest acid of this series. Similar reversals of solution acidity orders in the gas phase have recently been reported by Brauman and Blair³ and Tiernan and Hughes.⁴ It is apparent from these results that the properties of the solvent and effects of aggregation are of great importance in determining solution acidity orders.

The gas-phase reactions of OH^- are extremely fast relative to reaction rates in solution. For example, one of the fastest OH^- reactions in solution is the reaction with the hydronium ion, H_3O^+ , which has a diffusion-controlled rate constant of $1.4 \times 10^{11} \text{ M}^{-1} \text{ sec}^{-1}$ at 25°. The rate constants for the gas-phase reactions of OH^- with olefins vary between 1.56 and $5.3 \times 10^{11} \text{ M}^{-1} \text{ sec}^{-1}$ (see Table II). In addition, the gas-phase reactions are calculated to be very efficient, with reaction probabilities, P , ranging from 0.11 to 0.46.

The generation of carbanions from slightly acidic olefins is of great interest in solution studies. Although the production of carbanions from the reactions of OH^- with olefins is extremely efficient in the gas phase where the reactions are exothermic or thermoneutral, it is generally inhibited in solution where anion-solvent interaction is likely to render the generation of the carbanions endothermic. The energetics of the reaction of OH^- with olefins in solution may be considered in terms of eq 16.



If the solvation energy of OH^- is larger than the solvation energy of R^- by an amount greater than the exothermicity of the unsolvated gas-phase reaction, then solvation will cause the forward reaction to be endothermic. Unfortunately little thermochemical data are available on the appropriate heats of solvation of negative ions. Recent gas-phase investigations are, however, beginning to yield these important quantities for both positive and negative ions.^{16,17} For example,

(14) D. J. Cram, "Fundamentals of Carbanion Chemistry," Academic Press, New York, N. Y., 1965. See, however, the results of Steiner and Gilbert which indicate that the pK_a 's of water and triphenylmethane ($pK_a = 33$) are approximately equal: E. C. Steiner and J. M. Gilbert, *J. Amer. Chem. Soc.*, **85**, 3054 (1963).

(15) M. Eigen, *Angew. Chem. Intern. Ed. Engl.*, **3**, 1 (1964).

(16) P. Kebarle, S. K. Searles, A. Zolla, J. Scarborough, and M. Arshadi, *Advan. Mass Spectrom.*, **4**, 621 (1968).

(17) N. G. Adams, D. K. Bohme, D. B. Dunkin, F. C. Fehsenfeld, and E. E. Ferguson, *J. Chem. Phys.*, **52**, 1951 (1970).

the observation of competitive solvation reactions in the gas phase of the type indicated by eq 17 yields

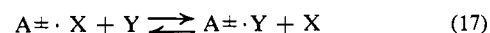

information on relative heats of solvation in the absence of interference from the bulk of the solvent. Some results of the present study indicated, for example, that $\text{O}_2^- \cdot \text{O}_2$ and $\text{O}_2^- \cdot \text{H}_2\text{O}$ failed to react with C_2H_4 in the gas phase to yield the solvated ion $\text{O}_2^- \cdot \text{C}_2\text{H}_4$ which suggests that the interaction of O_2 and H_2O with O_2^- is stronger than the interaction of C_2H_4 with O_2^- . It is anticipated that in protic solvents the OH^- solvation energy will be greater than the R^- solvation energy, thus rendering the forward reaction in eq 16 endothermic. However, if an appropriate dipolar aprotic solvent were available which solvated the carbanion more effectively than OH^- , the formation of the carbanion should remain exothermic in solution. It seems possible that this goal is accessible since Schriesheim has recently reported that potassium hydroxide in hexamethylphosphoramide at 55° abstracts a proton from acetonitrile ($pK_a = 25$) to generate an anion which reacts with 1,3-butadiene to give addition products.¹⁸ Preliminary investigations into the reaction of negative ions with acetonitrile in the gas phase using the flowing afterglow technique indicate that OH^- as well as H^- and NH_2^- react rapidly with acetonitrile to yield the CH_2CN^- anion.

Reactions of Carbanions with Molecular Oxygen.

It has been found that the carbanions generated in these investigations react with molecular oxygen in three ways: by electron transfer, hydride ion transfer, and rearrangement. The experimentally determined reaction channels, branching ratios, and rate constants as well as the calculated reaction probabilities for the reactions of carbanions with oxygen are summarized in Table III. The various reaction channels listed in Table III were demonstrated to arise from the reaction of O_2 with the carbanions by varying the O_2 flow in the reaction system and observing the corresponding increases in the product ion signals with increasing O_2 flow. The product ion masses were assigned molecular formulas in the following ways. According to stoichiometry the m/e 32 ion can be CH_4O^- or O_2^- . Measurement of the (P+1)/P isotope ratio gave a value of 0.004 to 0.005 which is consistent with the natural isotope abundance ratio of 0.0008 for O_2^- but not consistent with 0.018 for CH_4O^- . The presence of some O_2H^- , m/e 33, may have caused the observed (P+1)/P isotope ratio to be somewhat larger than the natural isotope abundance ratio for O_2 . According to stoichiometry the m/e 33 ion can be O_2H^- or CH_3O^- but is most probably O_2H^- since the structure CH_3O^- is unlikely and since formation of the latter ion would involve the making and breaking of several bonds, whereas a mechanistically simple path exists for the formation of O_2H^- . The m/e 39 ion is determined by stoichiometry to be C_3H_3^- . The m/e 41 ion can be C_2HO^- or C_3H_5^- . Measurement of the (P+1)/P isotope ratio for the m/e 41 ion in the reaction of C_3H_3^- with O_2 indicated the formula C_2HO^- . In addition, the formula C_3H_5^- is inconsistent with the experimental data. The m/e 41 ion produced by

(18) A. Schriesheim, *Amer. Chem. Soc., Div. Petrol. Chem., Prepr.*, **14**, D9 (1969).

Table III. Branching Ratios, Rate Constants, and Reaction Probabilities for the Reactions of Carbanions with Molecular Oxygen at 22.5°

Reaction	Branching ratio ^a	k_{exptl}^b , $M^{-1} \text{ sec}^{-1}$	k_L^c , $M^{-1} \text{ sec}^{-1}$	P^d
$C_3H_3^- + O_2 \rightarrow C_2HO^- + H_2CO$		6.0 (8) ^e	5.2 (11)	0.001
$C_3H_5^- + O_2 \rightarrow O_2^- + C_3H_5$	0.98 ± 0.01	1.7 (11)	5.2 (11)	0.33
$\rightarrow C_2H_3O^- + CH_2O$	0.02 ± 0.01			
$C_4H_7^- / + O_2 \rightarrow O_2^- + C_4H_7$	0.69 ± 0.05	1.9 (11)	5.0 (11)	0.38
$\rightarrow C_3H_3^- + CH_4O_2$	0.14 ± 0.03			
$\rightarrow O_2H^- + C_4H_6$	0.08 ± 0.04			
$\rightarrow C_2HO^- + C_2H_6O$	0.05 ± 0.02			
$\rightarrow C_2H_3O^- + C_2H_4O$	0.04 ± 0.01			
$C_4H_7^- \sigma + O_2 \rightarrow O_2H^- + C_4H_6$	0.62 ± 0.05	3.2 (11) ^h	5.0 (11)	0.64
$\rightarrow O_2^- + C_4H_7$	0.34 ± 0.03			
$\rightarrow C_2H_3O^- + C_2H_4O$	0.02 ± 0.01			
$\rightarrow C_2HO^- + C_2H_6O$	0.01 ± 0.01			
$\rightarrow C_3H_3^- + CH_4O_2$	0.01 ± 0.01			

^a The listed values and estimated errors represent averages of values obtained by two distinct methods (see Experimental Section). ^b Rate constant for loss of carbanion. To convert rate constants to $\text{cm}^3 \text{ molecule}^{-1} \text{ sec}^{-1}$ divide by 6×10^{20} . ^c Theoretical collision rate constant. ^d Reaction probability, k_{exptl}/k_L . ^e (8) denotes 10^8 . ^f Ion derived from 2-methylpropene. ^g Ion derived from 1- or *cis*- or *trans*-2-butene. ^h Average value for 1- and *cis*- and *trans*-2-butene.

the reaction of $C_3H_3^-$ and $C_4H_7^-$ with O_2 did not appear to react further with O_2 , whereas independent experiments indicated that $C_3H_5^-$ reacts rapidly with O_2 , principally by charge transfer. A similar argument was applied to the identification of the *m/e* 43 ion. The formula $C_2H_3O^-$ was assigned on the basis of both the failure to observe further reaction of the *m/e* 43 ion with oxygen and the assumption that $C_3H_7^-$ transfers an electron to O_2 as does $C_3H_5^-$.

The types of reactions which the carbanions were observed to undergo with molecular oxygen are consistent with the expected structures of these ions. Thus the propynyl anion formed by proton abstraction from allene does not transfer an electron to oxygen, but instead reacts in a slow process to yield C_2HO^- and a neutral fragment, presumably formaldehyde. Electron transfer apparently does not occur because the electron affinity of C_3H_3 , propynyl radical, is greater than that of O_2 . The rearrangement reaction may be pictured as in eq 18. The ion HC_2O^- is an enolate-type ion and should be moderately stable. The allyl anion

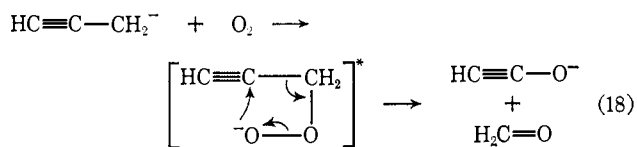

reacts with oxygen to yield almost exclusively O_2^- and the allyl radical. This illustrates the lower electron affinity of the allyl radical relative to the propynyl radical and is consistent with the lower electronegativity of the sp^2 -hybridized allyl radical compared to the predominantly sp -hybridized propynyl radical. The formation of the minor product ion $C_2H_3O^-$ from the reaction of allyl anion with oxygen may occur in a fashion (eq 19) analogous to that pictured for the reaction of the propynyl anion (eq 18). The driving force for this reaction may be provided by the formation of the stable enolate ion.

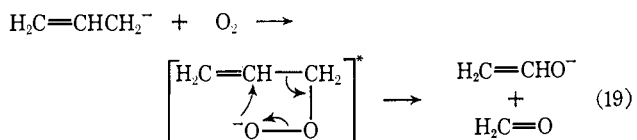

The linear butenes, 1-butene and *cis*- and *trans*-2-butene, all react with OH^- to give the same carbanion, $C_4H_7^-$. This is demonstrated by the fact that the carbanion generated from each of these butenes reacts with molecular oxygen with the same rate constant to give the same product ion distribution (see Table III). Therefore, this carbanion is most reasonably represented as the 1-methylallyl anion, $CH_3\overline{C}HCHCH_2^-$. This anion reacts with oxygen predominantly by hydride ion transfer, eq 20. A product channel of sec-

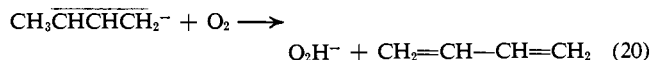

ondary importance for the reaction of this carbanion is electron transfer to form O_2^- . Apparently the hydride ion transfer channel predominates over electron transfer because the stable neutral, 1,3-butadiene, may be formed in the former reaction. Minor products (<2%) formed in the reaction of the 1-methylallyl anion with oxygen are the ions $C_2H_3O^-$, C_2HO^- , and $C_3H_3^-$. Formation of $C_2H_3O^-$ may occur as illustrated in eq 21. We do not have a simple explanation for formation of the other product ions. The carbanion produced in the reaction of 2-methylpropene with

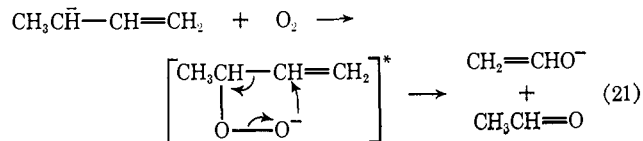

hydroxide ion reacts with oxygen in a distinctly different fashion and at a different rate than the 1-methylallyl anion. Thus it seems reasonable to assume that the ion produced from 2-methylpropene is the 2-methylallyl anion, $CH_2C(CH_3)\overline{C}H_2^-$. The product channels for the reaction of this carbanion with oxygen resemble the product channels of the reaction of the allyl anion more than those of the reaction of the 1-methylallyl anion as would be anticipated from the proposed structure. Thus the reaction of the 2-methylallyl anion with oxygen proceeds principally by electron transfer instead of hydride ion transfer. Minor product ions in the reaction of the 2-methylallyl anion with oxygen are $C_3H_3^-$ (14%), O_2H^- (8%), C_2HO^- (5%), and $C_2H_3O^-$ (4%). The formation of $C_3H_3^-$ can be thought

Table IV. Thermochemical Data

Carbanion	$\Delta H_f^\circ(\text{R}^-)$, kcal/mol	$EA(\text{R}\cdot)$, eV			Lit. values
		From heats of formation ^a	From bond energies ^a	From $EA(\text{O}_2)$ = 0.43 eV ^a	
C_2H_3^-	(>38) ^b	(<1.4)	(<1.27)		
C_3H_3^-	[≤ 63], ^c (≤ 71)			>0.43	0.34 ^d
C_3H_5^-	(≤ 30)	(≥ 0.46)	(≥ 0.57)	≤ 0.43	2.1, ^e 0.24, ^f >0.5, ^g 0.52 \pm 0.01 ^h
C_4H_7^-					
<i>i</i>	[≤ 17], (≤ 25)				
<i>j</i>	[≤ 15], (≤ 24)				
<i>l</i>	[≤ 14], (≤ 23)				
<i>m</i>	(≤ 22)		(≥ 0.06)	≤ 0.43	

^a See text. ^b Parentheses indicate that the enclosed value was obtained from the reaction of OH^- or the failure of OH^- to react. ^c Square brackets indicate that the enclosed value was obtained from the reaction of O^- . ^d F. M. Page and G. C. Goode, "Negative Ions and the Magnetron," Wiley-Interscience, New York, N. Y., 1969. ^e From ref 26. ^f N. S. Hush and J. A. Pople, *Trans. Faraday Soc.*, **51**, 600 (1955). ^g From ref 9. ^h J. R. Hoyland and L. Goodman, *J. Chem. Phys.*, **36**, 21 (1962). ⁱ Carbanion derived from 1-butene. ^j Carbanion derived from *cis*-2-butene. ^k One C-H bond dissociation energy of 3.58 eV used for the three linear butenes. ^l Carbanion derived from *trans*-2-butene. ^m Carbanion derived from 2-methylpropene.

to result from the elimination of methane from the 2-methylallyl anion. The production of O_2H^- can be rationalized as in eq 22. There appears to be no

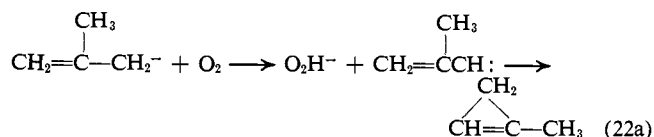

or

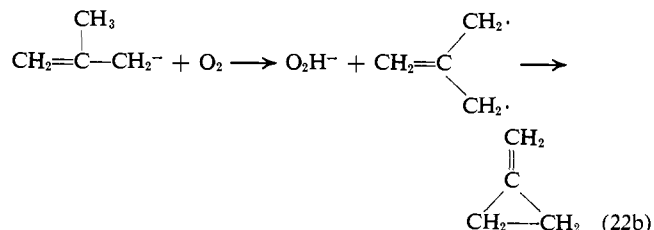

simple explanation for the formation of $\text{C}_2\text{H}_3\text{O}^-$ or C_2HO^- .

The reaction probabilities, P , for the reaction of the carbanions with oxygen are summarized in Table III. The reaction of the propynyl anion, C_3H_3^- , with oxygen is very inefficient (less than 1 reaction/1000 collisions) in comparison with the various allylic carbanions which react with probabilities of 0.33 to 0.64. This is not unreasonable since several bonds must be made and broken in order for the propynyl anion reaction to occur. The allyl anion and the 2-methylallyl anions which react mainly by electron transfer have very similar reaction probabilities, 0.33 and 0.38, respectively. The 1-methylallyl anion has an additional reaction channel available, hydride ion transfer, and reacts about twice as efficiently as the other allylic anions ($P = 0.64$). Thus in the reactions of the carbanions with oxygen, electron transfer and hydride ion transfer occur with high efficiencies whereas the rearrangement process occurs with a lower probability.

It is interesting to note a parallel between gas-phase and solution chemistry in the reaction of carbanions with oxygen. Russell and Bemis¹⁹ have studied the base-catalyzed reaction of triphenylmethane with oxygen and suggested that reaction proceeds *via* electron transfer from the triphenylmethide anion to oxygen

(19) G. A. Russell and A. G. Bemis, *J. Amer. Chem. Soc.*, **88**, 5491 (1966).

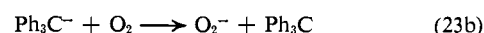
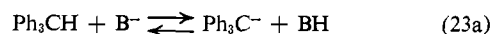

Thermochemical Results. The observation of rapid ion-molecule reactions in the gas phase can be used to set limits on the standard heats of formation of product species if the standard heats of formation of the remaining species which participate in the reaction are known. At the thermal energies of this experiment the observation of a fast reaction can be taken to indicate that the reaction is thermoneutral or exothermic. For a thermoneutral or exothermic reaction the standard enthalpy change $\Delta H^\circ \leq 0$. We have used this criterion to ascertain upper limits to the standard heats of formation of the carbanions C_3H_3^- , C_3H_5^- , and C_4H_7^- . The fast reactions of O^- and OH^- with the corresponding olefins which lead to predominant formation of the carbanion are taken to be exothermic. The results are listed in Table IV. The standard heats of formation of the neutral species were taken from Benson²⁰ with the exception of the heats of formation of the C_4H_8 hydrocarbons which were taken from Lange.²¹ Electron affinities of 1.465 ± 0.005 and 1.83 ± 0.04 eV were used for O and OH, respectively.^{22,23}

The failure to observe a reaction of a primary ion may be taken to be an indication of reaction endothermicity since most exothermic ion-molecule reactions proceed rapidly with little or no activation energy. For example, the failure to observe a measurable reaction between OH^- and ethylene strongly suggests, but does not prove, that the formation of the C_2H_3^- carbanion *via* this reaction is endothermic. Such information can be used to estimate lower limits for the standard heats of formation of carbanions and has been used to obtain a lower limit estimate for the standard heat of formation of C_2H_3^- which is listed in Table IV. When a primary ion reacts rapidly to yield several product ions, the failure to observe a particular product channel suggests that this channel is endothermic. However, in this case caution

(20) S. W. Benson, "Thermochemical Kinetics," John Wiley & Sons, Inc., New York, N. Y., 1968.

(21) N. A. Lange, Ed., "Handbook of Chemistry," 10th ed, McGraw-Hill Book Co., Inc., New York, N. Y., 1961, pp 1631-1648.

(22) L. M. Branscomb, D. S. Burch, S. J. Smith, and S. Geltman, *Phys. Rev.*, **111**, 504 (1958).

(23) L. M. Branscomb, *ibid.*, **148**, 11 (1966).

must be exercised since there is insufficient knowledge presently available concerning the competition between various product channels. Hence we did not feel justified to apply the criterion of endothermicity in these cases.

Since the heat of formation of a carbanion is related to the electron affinity of the corresponding free radical, eq 24, a knowledge of the heat of formation of the

$$\Delta H_f^\circ(\text{R}^-) = \Delta H_f^\circ(\text{R}\cdot) - EA(\text{R}\cdot) \quad (24)$$

free radical allows the estimation of the electron affinity of the free radical. Such estimates have been made using the limits of $\Delta H_f^\circ(\text{R}^-)$ obtained in the present experiments and Benson's values of $\Delta H_f^\circ(\text{R}\cdot)$.²⁰ The results are listed in Table IV.

Table IV also lists limits to the electron affinities of the unsaturated free radicals estimated from bond energy calculations. The criteria used to establish exothermicity, thermoneutrality, and endothermicity were as described above, that is, rapid formation of the carbanion, R^- , by the reaction of the base, A^- , with the olefin, RH , is assumed to indicate that the reaction is thermoneutral or exothermic. If this is the case, then

$$EA(\text{R}\cdot) \geq EA(\text{A}\cdot) + D(\text{R-H}) - D(\text{A-H}) \quad (25)$$

Here D refers to the bond dissociation energy. Also, failure to observe a reaction between A^- and RH is assumed to indicate that the reaction is endothermic. In this case

$$EA(\text{R}\cdot) < EA(\text{A}\cdot) + D(\text{R-H}) - D(\text{A-H}) \quad (26)$$

Bond dissociation energies of 4.40 ± 0.01 and 5.114 eV were used for O-H and H-OH.²⁴ The C-H bond dissociation energies for propene and the linear butenes were taken from Golden and Benson.²⁵ All other bond dissociation energies were taken from Vedeneyev, *et al.*²⁶

The final estimation of the electron affinities of the unsaturated free radicals was based on the further reaction of the corresponding carbanions with oxygen. The carbanions C_3H_5^- and C_4H_7^- were found to react rapidly with oxygen by electron transfer whereas the C_3H_3^- carbanion reacted only very slowly with oxygen *via* rearrangement (Table III). These results suggest that the electron affinities of $\text{C}_3\text{H}_5\cdot$ and $\text{C}_4\text{H}_7\cdot$ are less than that of oxygen and that the electron affinity of $\text{C}_3\text{H}_3\cdot$ is greater than that of oxygen. These electron affinity limits are included in Table IV where $EA(\text{O}_2)$ has been taken to be 0.43 eV.²⁷ Experimentally determined values for $EA(\text{O}_2)$ reported in the literature vary from 0.43 ± 0.02 eV obtained by Pack and Phelps²⁷ to ≥ 1.1 eV obtained by Stockdale, *et al.*²⁸ This discrepancy has as yet not been resolved, although the former value is currently considered to be the more accurate. The electron affinity limits set by the bond

(24) G. Herzberg, "Molecular Spectra and Molecular Structure," D. Van Nostrand Co., Inc., New York, N. Y.: Vol. I. "Spectra of Diatomic Molecules," 2nd ed, 1953; Vol III. "Electronic Spectra and Electronic Structure of Polyatomic Molecules," 1966.

(25) D. M. Golden and S. W. Benson, *Chem. Rev.*, **69**, 125 (1969).

(26) V. I. Vedeneyev, L. V. Gurvich, V. N. Kondrat'yev, V. A. Medvedev, and Ye. L. Frankevich, "Bond Energies, Ionization Potentials, and Electron Affinities," St. Martin's Press, New York, N. Y., 1966.

(27) A. V. Phelps and J. L. Pack, *Phys. Rev. Lett.*, **6**, 111 (1961).

(28) J. A. D. Stockdale, R. N. Compton, G. S. Hurst, and P. W. Reinhardt, *J. Chem. Phys.*, **50**, 2176 (1969).

energy calculations and the heat of formation calculations do, however, seem to be more consistent with a slightly higher value for $EA(\text{O}_2)$ than 0.43 eV.

Conclusion

It may be of interest to describe what we feel to be the most important features of the flowing afterglow technique and to relate these to other techniques commonly used for the study of ion-molecule reactions. The significant features of the flowing afterglow technique are the following. The region of production of ions is separated in space (and time) from the reaction region. This is accomplished by producing the ion either directly by ionizing the parent gas of the ion or indirectly by secondary reaction in a rapidly flowing ($v \sim 10^4$ cm/sec) buffer gas *upstream* from the point of addition of reactant gas. The ions are in thermal equilibrium when they enter the reaction region, *i.e.*, the ions are energetically equilibrated to the buffer gas temperature (22.5°) and are likely to be in their ground electronic state. Finally, rate constants and reaction channels for the reaction of a particular ion with an added reactant gas are easily determined by observing the ion mass spectrum as a function of reactant gas addition.

The spatial separation of ion-production and reaction regions is a desirable feature of the flowing afterglow system since the reactant ions undergo *ca.* 10^4 collisions with the buffer gas before entering the reaction region and thus are likely to be in their ground states. In addition, the presence of the desired reactant ion and any other ions produced incidentally can be established before the reactant gas is added. All ions present can be monitored so that it can be established with confidence that the observed product ions arise from a certain reaction. Ion-production and reaction regions are separated in the tandem mass spectrometric technique, but usually not in simple mass spectrometry or in ion cyclotron resonance (icr) spectrometry.

In the flowing afterglow system reactant ions are at thermal equilibrium at room temperature. In tandem mass spectrometry ions with energies as low as 0.3 eV can be produced, but recent results from this laboratory and from Hughes and Tiernan⁹ for the reaction $\text{O}^- + \text{CH}_3\text{Cl}$ show that the distribution among the various reaction channels changes very significantly in changing the ion energy from 0.04 (flowing afterglow) to 0.3 eV (tandem mass spectrometer). The reason for this change is more easily appreciated when it is noted that an ion energy of 0.3 eV corresponds to an ion temperature of *ca.* 2300°K. The energy states of ions utilized in simple mass spectrometry are usually not well characterized.

Finally, *thermal energy* reaction rate constants for ion-molecule reactions can be measured very conveniently using the flowing afterglow technique. If ion-molecule reactions are to be rationalized by theoretical treatment, it is imperative that reactant energies be known and desirable for them to be in their ground states. In addition, if extrapolations from the gas phase to solution are ever to be made, it would appear that it is desirable to start with gas-phase measurements under conditions of thermal equilibrium since ion-molecule reactions in solution always occur under conditions of thermal equilibrium.

It is apparent that the simplicity and versatility of the flowing afterglow technique make it a very useful technique for the study of gas-phase organic ion-molecule reactions. At the present time, the most serious drawbacks for the study of organic reactions are that rate constants are obtainable only when the reactant is a gas at atmospheric pressure and that for qualitative measurements the organic compounds used must have a fairly high vapor pressure at the system pressure (ca.

0.4 Torr). These limitations, however, still allow the study of a large number of organic reactions.

Acknowledgments. We thank Dr. E. E. Ferguson and Dr. F. C. Fehsenfeld from the Aeronomy Laboratory, Environmental Sciences Services Administration Research Laboratories, and Professor C. H. DePuy from the Department of Chemistry, University of Colorado, for helpful discussions.

Electron Spin Resonance Spectra of Radicals Produced by Hydrogen and Deuterium Bombardment of Unsaturated Organic Compounds at 77°K

Cornelius U. Morgan and Kevin J. White

Contribution from U. S. Army Ballistic Research Laboratories, Aberdeen Proving Ground, Maryland 21005. Received August 13, 1969

Abstract: The radicals produced by the interaction of unsaturated hydrocarbons with hydrogen atoms at 77°K have been studied by electron spin resonance (esr). The hydrogen atom adds directly to the double bond of ethylene, 1,3-butadiene, and benzene to produce the ethyl, 2-butenyl, and cyclohexadienyl radicals, respectively. In the case of the interaction of hydrogen atoms with 1-butyne and 1,2-butadiene, the methylallenyl radical was observed in each case. On bombardment of 1,4-cyclohexadiene and propyne with hydrogen atoms the cyclohexadienyl and allenyl radicals were observed. These last four reactions can be explained by assuming an addition reaction of hydrogen with the compound. The radical produced immediately abstracts a hydrogen atom from the parent compound to yield the observed stable radical. For the 1,2-butadiene-hydrogen interaction, such a mechanism accounts for the esr spectrum and for the 2-butyne and 2-butene observed by Klein and Scheer¹ in their analysis of the products of this reaction after warming to room temperature. The formation of 2-butene and 2-butyne can also be explained, respectively, by a double addition and an addition and abstraction reaction of hydrogen with 1,2-butadiene. In this case the radical observed by esr would be explained by a single abstraction reaction.

In recent years considerable interest has arisen concerning the interaction of hydrogen atoms with unsaturated hydrocarbons held at or near liquid nitrogen temperatures, as in the work of Klein and Scheer.²⁻⁸ The number of reactions initiated at this temperature is reduced considerably when compared with the same reaction at ambient temperatures. Klein and Scheer have used the gas chromatographic technique to study the reaction of these products after they have warmed to room temperature and from these data have inferred some of the low-temperature hydrogen-olefin reactions. In numerous cases they have found that the radical disappears by disproportionation and dimerization reactions when the radicals are free to migrate as the compound is warmed. For some matrices, particularly propane, the radical is able to migrate even at 77°K. In most of these reactions the initial step is the hydrogen addition to the double bond.

In this experiment we have attempted to observe by esr at 77°K the radicals produced in this initial reaction for both hydrogen and deuterium atom bombardment. Chachaty and Schmidt⁹ and Forchioni and Chachaty¹⁰ also carried out this procedure for compounds such as allyl alcohol, ethanol, isopropyl alcohol, and 2-chloroethanol. Others have performed these studies with solids at ambient temperatures.¹¹⁻¹³ We have chosen to examine the interaction of hydrogen atoms with ethylene, 1,2-butadiene, 1,3-butadiene, propyne, 1-butyne, benzene, and 1,4-cyclohexadiene.

Experimental Section

The gases used without purification in these determinations included Matheson ethylene (99.5%), propyne (96%), 1,3-butadiene (99.5%), deuterium (98.0%), and hydrogen (99.9%). Three of the liquids used were 1,2-butadiene (95%), 1-butyne (99.7%), and 1,4-cyclohexadiene (99%), obtained from the Chemical Samples Co. The benzene used was Fisher ACS grade.

The experimental apparatus used is shown in Figure 1. It is similar to that used by Chachaty and Schmidt. The volume of the dewar and gas handling system with the main stopcock to the pump

- (1) R. Klein and M. D. Scheer, *J. Phys. Chem.*, **67**, 1874 (1963).
- (2) R. Klein, M. D. Scheer, and R. Kelley, *ibid.*, **68**, 598 (1964).
- (3) R. Klein and M. D. Scheer, *ibid.*, **66**, 2677 (1962).
- (4) R. Klein and M. D. Scheer, *ibid.*, **65**, 375 (1961).
- (5) R. Klein, M. D. Scheer, and J. G. Waller, *ibid.*, **64**, 1247 (1960).
- (6) R. Klein and M. D. Scheer, *J. Amer. Chem. Soc.*, **80**, 1007 (1958).
- (7) R. Klein and M. D. Scheer, *Prepr. Pap. Int. Symp. Free Radicals*, **5th** 1961, No. 34 (1961).
- (8) R. Klein and M. D. Scheer, *J. Phys. Chem.*, **62**, 1011 (1958).

- (9) C. Chachaty and M. C. Schmidt, *J. Chim. Phys.*, **62**, 527 (1965).
- (10) A. Forchioni and C. Chachaty, *C. R. Acad. Sci., Paris, Ser. C*, **264**, 637 (1967).
- (11) L. A. Wall and R. B. Ingalls, *J. Chem. Phys.*, **41**, 1112 (1964).
- (12) T. Cole and H. C. Heller, *ibid.*, **42**, 1668 (1965).
- (13) J. N. Herak and W. Gordy, *Proc. Nat. Acad. Sci.*, **56**, 1354 (1966).